

# CEM4539



PRELIMINARY

## Dual Enhancement Mode Field Effect Transistor(N and P Channel)

5

### FEATURES

- 30V , 5.8A ,  $R_{DS(ON)}=37m\ \Omega$  @  $V_{GS}=10V$ .  
 $R_{DS(ON)}=55m\ \Omega$  @  $V_{GS}=4.5V$ .  
 -30V , -4.9A ,  $R_{DS(ON)}=53m\ \Omega$  @  $V_{GS}=-10V$ .  
 $R_{DS(ON)}=95m\ \Omega$  @  $V_{GS}=-4.5V$ .
- Super high dense cell design for extremely low  $R_{DS(ON)}$ .
- High power and current handling capability.
- Surface Mount Package.

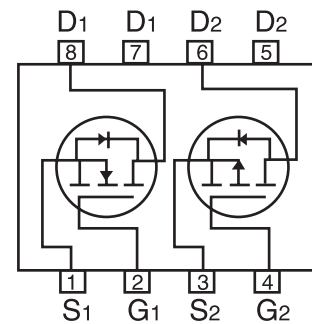
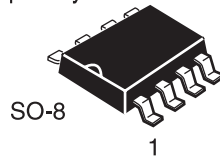

### ABSOLUTE MAXIMUM RATINGS ( $T_A=25^{\circ}C$ unless otherwise noted)

Parameter	Symbol	N-Channel	P-Channel	Unit
Drain-Source Voltage	$V_{DS}$	30	-30	V
Gate-Source Voltage	$V_{GS}$	$\pm 20$	$\pm 20$	V
Drain Current-Continuous <sup>a</sup> @ $T_J=125^{\circ}C$ -Pulsed <sup>b</sup>	$I_D$	$\pm 5.8$	$\pm 4.9$	A
	$I_{DM}$	$\pm 30$	$\pm 30$	A
Drain-Source Diode Forward Current <sup>a</sup>	$I_S$	1.7	-1.7	A
Maximum Power Dissipation <sup>a</sup>	PD	2		W
Operating Junction and Storage Temperature Range	$T_J, T_{STG}$	-55 to 150		$^{\circ}C$

### THERMAL CHARACTERISTICS

Thermal Resistance, Junction-to-Ambient <sup>a</sup>	$R_{\theta JA}$	62.5	$^{\circ}C/W$
--	-----------------	------	---------------

# CEM4539

## N-Channel ELECTRICAL CHARACTERISTICS (TA=25°C unless otherwise noted)

Parameter	Symbol	Condition	Min	Typ <sup>c</sup>	Max	Unit
<b>OFF CHARACTERISTICS</b>						
Drain-Source Breakdown Voltage	BV <sub>DSS</sub>	V <sub>GS</sub> =0V, I <sub>D</sub> =250μA	30			V
Zero Gate Voltage Drain Current	I <sub>DSS</sub>	V <sub>DS</sub> =30V, V <sub>GS</sub> =0V			1	μA
Gate-Body Leakage	I <sub>GSS</sub>	V <sub>GS</sub> =±20V, V <sub>DS</sub> =0V			±100	nA
<b>ON CHARACTERISTICS<sup>c</sup></b>						
Gate Threshold Voltage	V <sub>GS(th)</sub>	V <sub>DS</sub> =V <sub>GS</sub> , I <sub>D</sub> =250μA	1	1.4	3	V
Drain-Source On-State Resistance	R <sub>DS(ON)</sub>	V <sub>GS</sub> =10V, I <sub>D</sub> =5.8A		30	37	mΩ
		V <sub>GS</sub> =4.5V, I <sub>D</sub> =4.7A		41	55	mΩ
On-State Drain Current	I <sub>D(ON)</sub>	V <sub>GS</sub> =10V, V <sub>DS</sub> =5V	15			A
Forward Transconductance	g <sub>FS</sub>	V <sub>DS</sub> =15V, I <sub>D</sub> =5.8A		12		S
<b>DYNAMIC CHARACTERISTICS<sup>c</sup></b>						
Input Capacitance	C <sub>ISS</sub>	V <sub>DS</sub> =15V, V <sub>GS</sub> =0V f=1.0MHz		500	650	pF
Output Capacitance	C <sub>OSS</sub>			267	350	pF
Reverse Transfer Capacitance	C <sub>RSS</sub>			93	120	pF
<b>SWITCHING CHARACTERISTICS<sup>c</sup></b>						
Turn-On Delay Time	t <sub>D(ON)</sub>	V <sub>DD</sub> =15V, I <sub>D</sub> =1A, V <sub>GS</sub> =10V, R <sub>GEN</sub> =6Ω		9	15	ns
Rise Time	t <sub>r</sub>			9	20	ns
Turn-Off Delay Time	t <sub>D(OFF)</sub>			25	50	ns
Fall Time	t <sub>f</sub>			20	35	ns
Total Gate Charge	Q <sub>g</sub>	V <sub>DS</sub> =15V, I <sub>D</sub> =5.8A, V <sub>GS</sub> =10V		34	55	nC
Gate-Source Charge	Q <sub>gs</sub>			6		nC
Gate-Drain Charge	Q <sub>gd</sub>			7		nC

# CEM4539

5

## P-Channel ELECTRICAL CHARACTERISTICS (TA=25 °C unless otherwise noted)

Parameter	Symbol	Condition	Min	Typ <sup>c</sup>	Max	Unit
<b>OFF CHARACTERISTICS</b>						
Drain-Source Breakdown Voltage	BV <sub>DSS</sub>	V <sub>GS</sub> =0V, I <sub>D</sub> =-250μA	-30			V
Zero Gate Voltage Drain Current	I <sub>DSS</sub>	V <sub>DS</sub> =-30V, V <sub>GS</sub> =0V			-1	μA
Gate-Body Leakage	I <sub>GSS</sub>	V <sub>GS</sub> =±20V, V <sub>DS</sub> =0V			±100	nA
<b>ON CHARACTERISTICS<sup>b</sup></b>						
Gate Threshold Voltage	V <sub>GS(th)</sub>	V <sub>DS</sub> =V <sub>GS</sub> , I <sub>D</sub> =-250μA	-1	-1.5	-3	V
Drain-Source On-State Resistance	R <sub>DS(ON)</sub>	V <sub>GS</sub> =-10V, I <sub>D</sub> =-4.9A		43	53	mΩ
		V <sub>GS</sub> =-4.5V, I <sub>D</sub> =-3.6A		70	95	mΩ
On-State Drain Current	I <sub>D(ON)</sub>	V <sub>DS</sub> =-5V, V <sub>GS</sub> =-10V	-20			A
Forward Transconductance	g <sub>FS</sub>	V <sub>DS</sub> =-15V, I <sub>D</sub> =-4.9A	5	10		S
<b>DYNAMIC CHARACTERISTICS<sup>c</sup></b>						
Input Capacitance	C <sub>ISS</sub>	V <sub>DS</sub> =-15V, V <sub>GS</sub> =0V f=1.0MHz		860	1120	pF
Output Capacitance	C <sub>OSS</sub>			457	600	pF
Reverse Transfer Capacitance	C <sub>RSS</sub>			140	190	pF
<b>SWITCHING CHARACTERISTICS<sup>c</sup></b>						
Turn-On Delay Time	t <sub>D(ON)</sub>	V <sub>D</sub> =-15V, R <sub>L</sub> =15Ω I <sub>D</sub> =-1A, V <sub>GEN</sub> =-10V, R <sub>GEN</sub> =6Ω		8	15	ns
Rise Time	t <sub>r</sub>			12	20	ns
Turn-Off Delay Time	t <sub>D(OFF)</sub>			23	40	ns
Fall Time	t <sub>f</sub>			14	25	ns
Total Gate Charge	Q <sub>g</sub>	V <sub>DS</sub> =-15V, I <sub>D</sub> =-4.9A, V <sub>GS</sub> =-10V		16	25	nC
Gate-Source Charge	Q <sub>gs</sub>			5		nC
Gate-Drain Charge	Q <sub>gd</sub>			2		nC

# CEM4539

## ELECTRICAL CHARACTERISTICS ( $T_A=25^\circ\text{C}$ unless otherwise noted)

Parameter	Symbol	Condition	Min	Typ <sup>c</sup>	Max	Unit
<b>DRAIN-SOURCE DIODE CHARACTERISTICS<sup>b</sup></b>						
Diode Forward Voltage	V <sub>SD</sub>	V <sub>GS</sub> = 0V, I <sub>S</sub> = 1.7A	N-Ch	0.7	1.2	V
		V <sub>GS</sub> = 0V, I <sub>S</sub> = -1.7A	P-Ch	-0.8	-1.2	

5

### Notes

- a. Surface Mounted on FR4 Board,  $t \leq 10\text{sec}$ .
- b. Pulse Test: Pulse Width  $\leq 300\ \mu\text{s}$ , Duty Cycle  $\leq 2\%$ .
- c. Guaranteed by design, not subject to production testing.

N-Channel

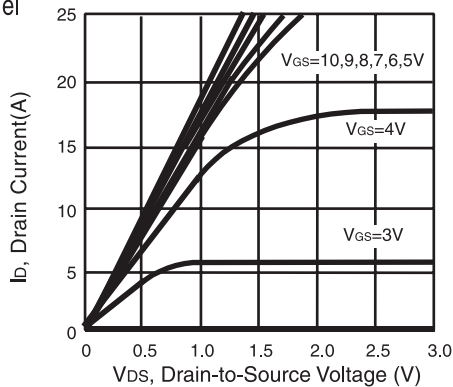

Figure 1. Output Characteristics

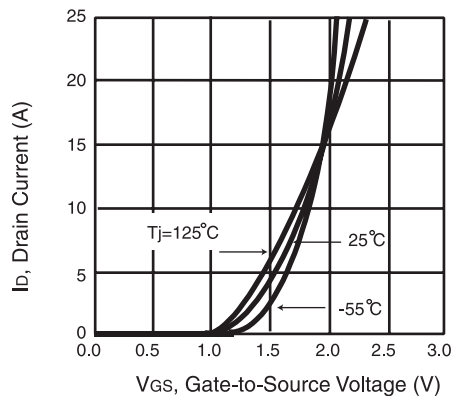

Figure 2. Transfer Characteristics

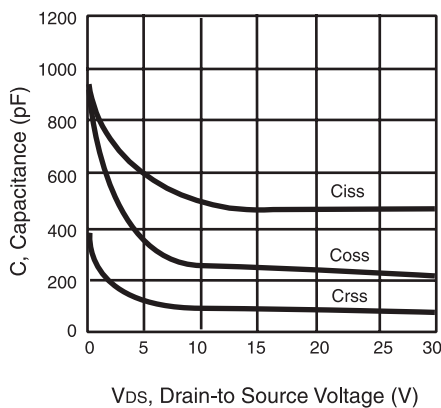

Figure 3. Capacitance

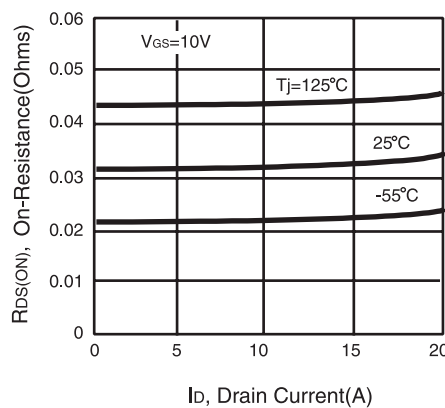
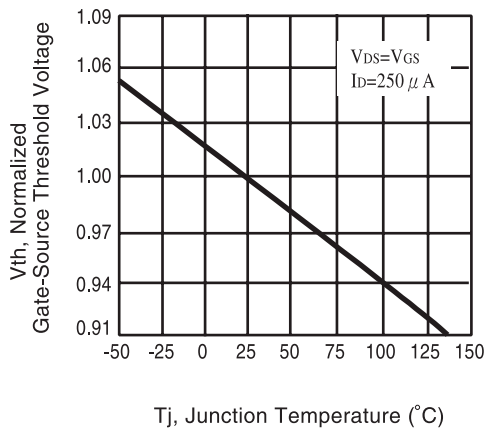

Figure 4. On-Resistance Variation with Drain Current and Temperature

# CEM4539

## N-Channel

5



**Figure 5. Gate Threshold Variation with Temperature**

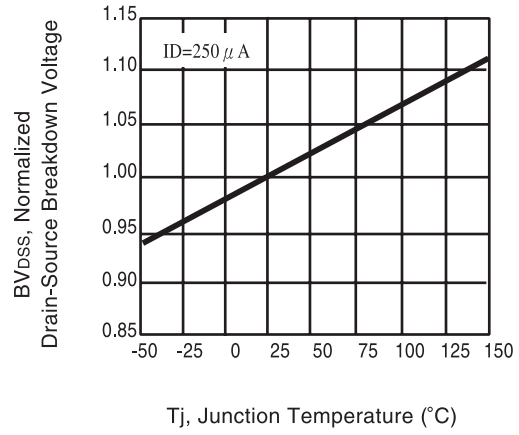

**Figure 6. Breakdown Voltage Variation with Temperature**

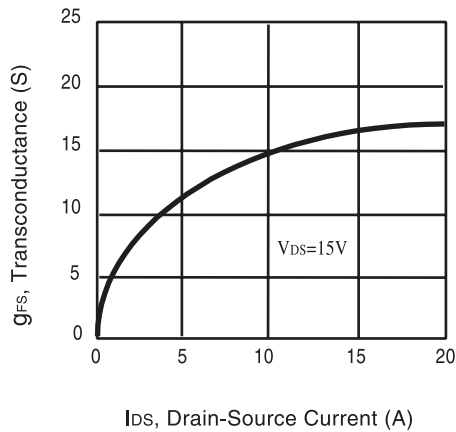

**Figure 7. Transconductance Variation with Drain Current**

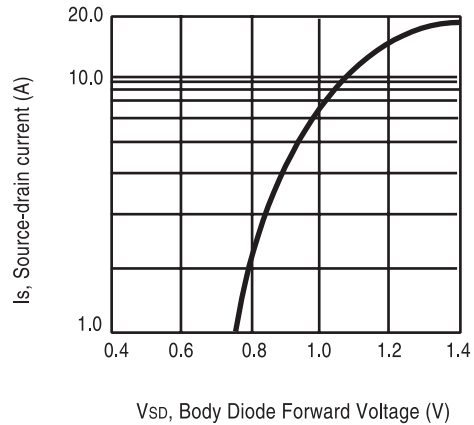

**Figure 8. Body Diode Forward Voltage Variation with Source Current**

# CEM4539

5

## P-Channel

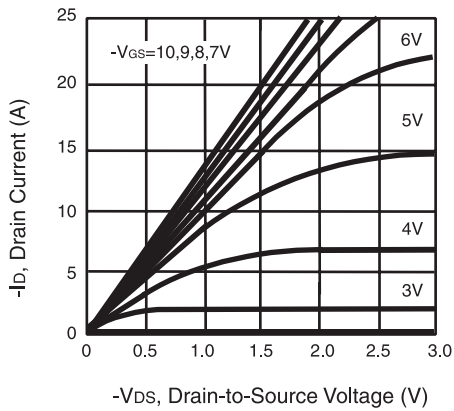

Figure 1. Output Characteristics

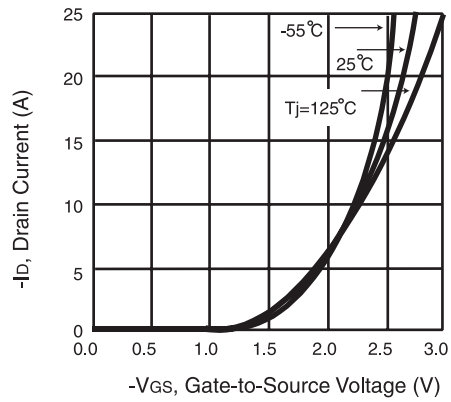

Figure 2. Transfer Characteristics

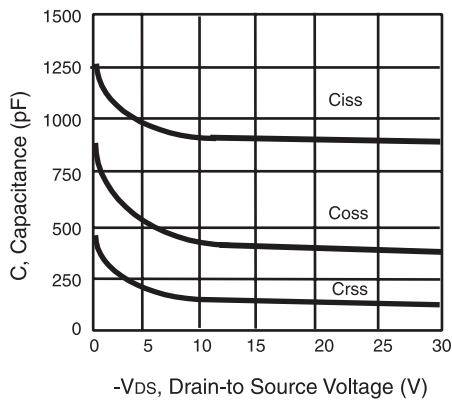

Figure 3. Capacitance

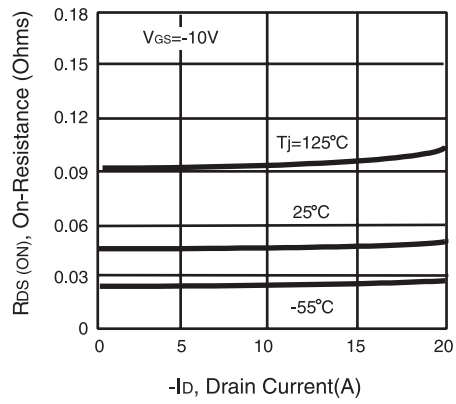

Figure 4. On-Resistance Variation with Drain Current and Temperature

# CEM4539

## P-Channel

5

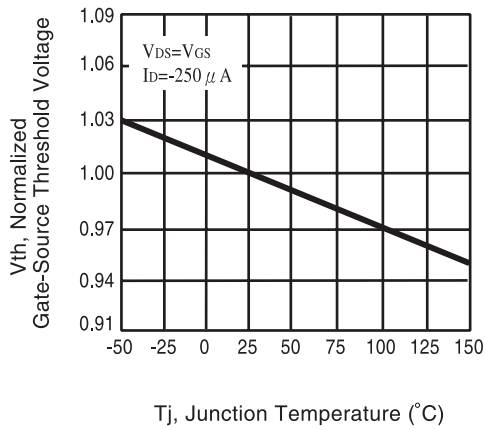

Figure 5. Gate Threshold Variation with Temperature

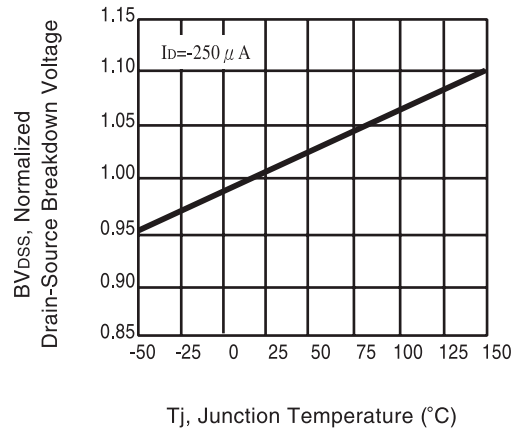

Figure 6. Breakdown Voltage Variation with Temperature

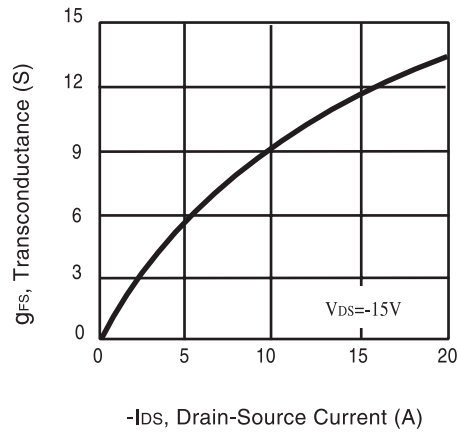

Figure 7. Transconductance Variation with Drain Current

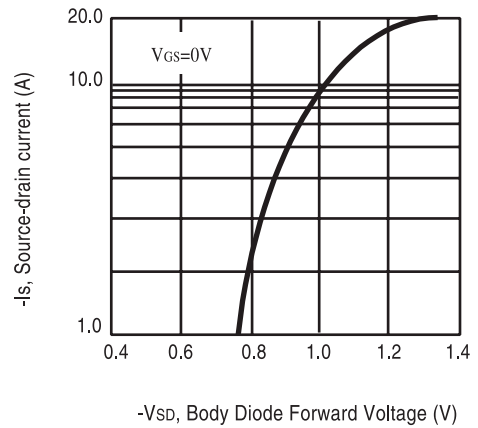

Figure 8. Body Diode Forward Voltage Variation with Source Current

# CEM4539

5

## N-Channel

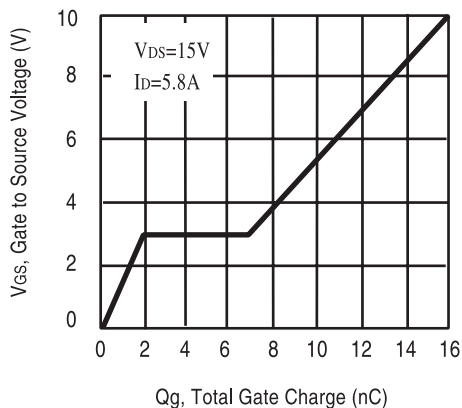

Figure 9. Gate Charge

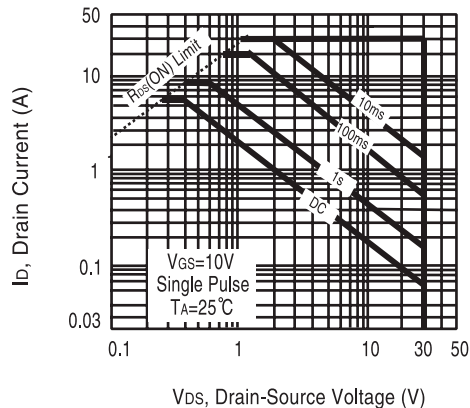

Figure 10. Maximum Safe Operating Area

## P-Channel

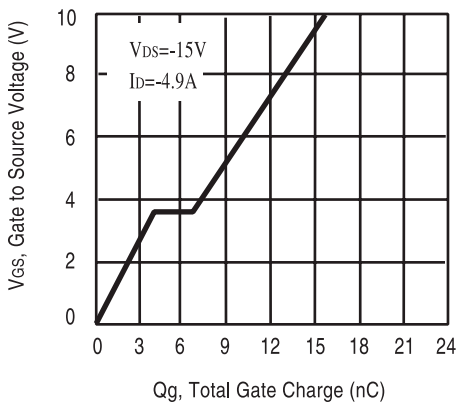

Figure 9. Gate Charge

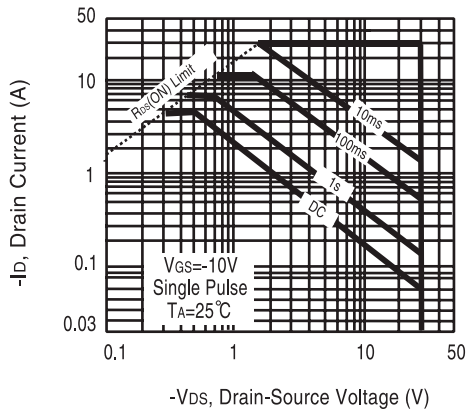

Figure 10. Maximum Safe Operating Area



# CEM4539

5

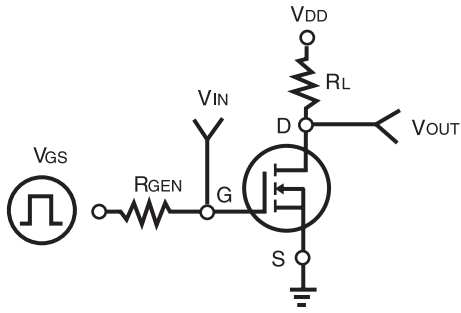

Figure 11. Switching Test Circuit

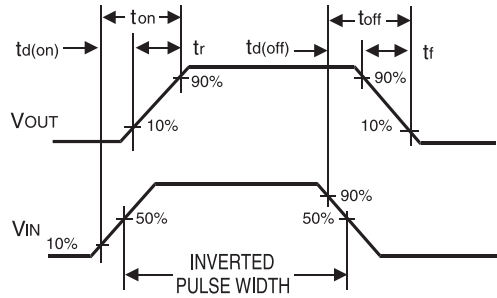

Figure 12. Switching Waveforms

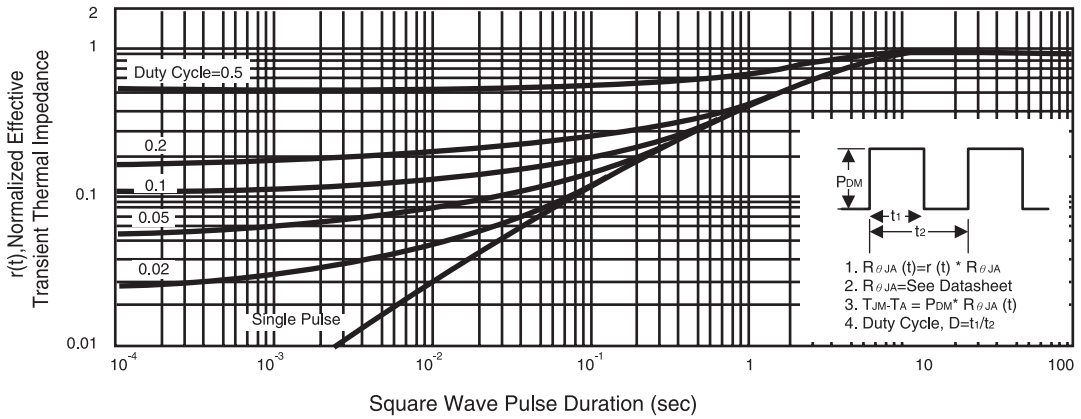

Figure 13. Normalized Thermal Transient Impedance Curve